



Operating manual

Standard planetary gearboxes

PLE/PLQE/PLPE/PLHE/PLFE
WPLE/WPLQE/WPLPE/WPLFE
PSBN/PSN/PLN/PSFN/PLFN
WPLN/WPSFN/WGN



DSS-Nr.	100225283
DSS-Rev.	008
Datum	11.06.2018



Contents

1	General information	3
1.1	Using the operating manual	3
1.2	Warnings in this operating manual	4
1.3	Safety and hazard symbol	5
1.4	Information symbols	5
1.5	Copyright	6
2	Safety notices	7
2.1	Initial comments	7
2.2	Standards and directives	7
2.3	Intended use	7
2.4	Reasonably foreseeable misuse	8
2.5	Staff qualification	8
2.6	General safety instructions	9
3	Description	11
3.1	Technical data	12
3.2	Accessories	12
3.3	Lubrication	13
3.4	Identification plate	13
3.5	Product code	14
4	Storage and transport	15
4.1	Storage	15
4.2	Transport	15
4.3	Condition upon delivery	16
5	Mounting	17
5.1	Ambient conditions	17
5.2	Preparations for mounting	18
5.3	Mounting motor on gearbox	18
5.4	Mounting gearbox	20
6	Commissioning	22
6.1	Measuring surface temperature	23
6.2	Sound emission	24
7	Maintenance and disposal	25
7.1	Maintenance intervals	25
7.2	Lubrication	26
7.3	Seals	28
7.4	Disposal	28
8	Operating faults	29
8.1	Remedying operating faults	29
9	Service	30

1 General information

1.1 Using the operating manual

This operating manual contains important information about how to safely and properly mount, transport, commission, maintain, and dispose of Neugart gearboxes with the following names:

**PLE / PLQE / PLPE / PLHE / PLFE / WPLE / WPLQE / WPLPE / WPLFE
PSBN / PSN / PLN / PSFN / PLFN / WPLN / WPSFN and WGN.**

In the remainder of these instructions, these planetary gearboxes are simply referred to as gearboxes.

The machine operator must ensure that these instructions are read and understood in full by everyone assigned/tasked with installing, operating or maintaining the gearbox.





These instructions must be kept close to the machine in which the gearbox is used so they are easily accessible and can be consulted immediately if needed. Anyone working near the machine must be familiar with the safety notices.

	Note
	Planetary gearboxes with a similar product name to those listed but start with an "X" [e.g. XPLN] are modified gearboxes. These gearboxes may have different characteristics to standard planetary gearboxes. If you have any questions, please contact the Neugart Service department (see Chapter 9: Service).

1.2 Warnings in this operating manual

1.2.1 Meaning of signal words

Warnings are used in this operating manual if there is a risk of personal injury or damage to property. The signal words in the warnings draw attention to particular hazards and indicate their severity.

Signal word	Meaning	Consequences of non-observance
 Danger	Direct, grave danger to life and limb	Serious injuries or even death
 Warning	Potential danger to life and limb	Serious injuries or even death
 Caution	Potential danger of minor injuries	Minor injuries
Attention!	Potential danger of damage to property or environmental damage	Damage to drive system or its surroundings
 Note	Particularly important information: Makes it easier to install and use the gearbox correctly and properly	May impair operating process

1.2.2 Structure of warnings

The warnings indicate potential hazards and state measures for avoiding them. The warnings are structured as follows:

Safety symbol	 SIGNAL WORD!
	Type of hazard, its source, and potential consequences of non-observance
	<ul style="list-style-type: none"> Measures for avoiding the hazard

1.3 Safety and hazard symbols

The following safety symbols are used in this operating manual to indicate hazards, warnings, and important information:



Warning of danger area



Warning of suspended loads



Warning of hot surface



Warning of risk of being dragged in



Warning of automatic start-up



Warning of risk of being crushed



Warning of hand injuries



Hazardous to the environment

1.4 Information symbols



Here you will find very important information that you should follow for correct and proper gearbox installation and use.

- Act. Call for action.



1.5 Copyright

Copyright for this operating manual remains with

Neugart GmbH, Kippenheim

The operating manual must not be reproduced, disseminated, used without authorization for the purpose of competition or shared with others in part or in whole. Infringements will result in compensation for damages.

All rights reserved, especially in the event that a patent is granted or other forms of registration.

The original operating manual is produced in German. All translations are based on the German version. Subject to technical modifications.

© 2017 Neugart GmbH, Kippenheim.

2 Safety notices

2.1 Initial comments

This chapter describes the safety notices you need to observe for safe gearbox use. It indicates potential hazard sources and generally required safety measures. In addition to these notices, please observe the statutory accident prevention and environmental protection regulations and the additional safety notices provided in the relevant chapters of this operating manual.

2.2 Standards and directives

2.2.1 Directive 2006/42/EG

Gearboxes are not machines or incomplete machines in the sense of the EU Directive 2006/42/EC. Gearboxes are components intended for installation in machines and systems. A declaration of conformity in the sense of this Directive is not therefore permitted for gearboxes.

The gearbox must not be commissioned within the area of application of Directive 2006/42/EC until it has been ascertained that the equipment in which the gearbox is being installed as a component complies with Directive 2006/42/EC.

2.2.2 CE labeling

Gearboxes are not machines or incomplete machines in the sense of the EU Directive 2006/42/EC. Gearboxes are components intended for installation in machines and systems. CE labeling is not therefore permitted for gearboxes.

2.3 Intended use

The gearboxes are only intended to be installed in a machine and/or system or to be combined with other components to form a machine and/or system.

The gearbox is used to convert torque and speed in industrial applications.

Observe the information relating to mounting and operation. The gearbox may only be operated within its technical specification (see Chapter 3.1: Technical data). If the permissible technical data is exceeded, permanent or sudden gearbox damage may result.

The machine manufacturer must undertake a risk assessment for the machine to ensure that appropriate measures are taken to ensure that the gearbox is used as intended and that unforeseen movements cannot cause injury to people or damage to property. Additional requirements of the technical staff may result from the risk assessment.

The gearbox may only be commissioned once the machine and/or system in which the gearbox is fitted as a component conforms to the requirements of the applicable directives and statutory regulations (see Chapter 2.2: Standards and directives).



2.4 Reasonably foreseeable misuse

Any gearbox use which exceeds the maximum permissible speeds, torques, temperatures or radial loads is not permitted (see Chapter 3.1: Technical data).

The gearboxes must not be operated in potentially explosive areas.

2.5 Staff qualification

Only qualified experts may undertake work such as transport, mounting, commissioning, and maintenance. Qualified experts are people familiar with the transport, installation, mounting, commissioning, and operation of gearboxes. They have the corresponding minimum qualifications needed for the work and have read and understood the operating manual.

Transport: only by staff with the corresponding qualification who have been appropriately trained in how to handle the product.



Installation: only by experts trained in mechanics.





Commissioning/maintenance: only by experts with extensive knowledge of drive technology. The experts must also be aware of and observe the national accident prevention regulations.

Experts are people who are able to assess the work assigned to them, recognize potential hazards, and take appropriate safety measures on the basis of their technical training, knowledge and experience, and their knowledge of the relevant requirements. Experts must observe the relevant technical rules.

Ensure that staff have read and understood the operating manual.

2.6 General safety instructions

	<p>⚠ Warning!</p> <p>Improper use, incorrect installation and operation, and insufficient maintenance may result in serious damage to property, serious injury, and even death.</p>
	<ul style="list-style-type: none"> • Observe the following general safety instructions. • Ensure intended use and observe the technical data. • Never use the gearbox with damaged parts. • Ensure that staff are qualified. • Only have gearbox repaired by Neugart.
	<p>⚠ Warning!</p> <p>Rotating components on the gearbox may be flung out and/or body parts may be drawn in by rotating parts. This may result in serious injury, and even death.</p>
	<ul style="list-style-type: none"> • Before using the gearbox, ensure that all shafts are correctly connected. • Remove or secure any shaft feather keys if the gearbox is being started up without a connected load. This will avoid the feather keys being flung out and the associated risk of injury. • Ensure that potential hazard sources are covered/secured (e.g. rotating parts). • Only work on a gearbox if it is stationary, the driving motor is switched off, and locked to prevent it from switching on again. • During operation, keep at a sufficient safe distance from the gearbox and its rotating parts.

	<p>⚠ Warning!</p> <p>Modifications and work on the gearbox may change the gearbox's technical data and therefore result in serious damage to property, serious injury, and even death.</p> <ul style="list-style-type: none"> • Do not change/modify the gearbox in any way. • Do not undertake any work on the gearbox other than that described in this operating manual.
	<p>⚠ Caution!</p> <p>There is a risk of hands and feet being crushed when handling the gearbox due to its inherent weight.</p> <ul style="list-style-type: none"> • Wear appropriate protective equipment (safety boots, protective gloves). • Ensure that the installation environment is clean. • Use appropriate lifting fixtures if needed.
	<p>⚠ Caution!</p> <p>The gearbox heats up during operation. Touching the gearbox housing may result in severe burns.</p> <ul style="list-style-type: none"> • Allow the gearbox to remain stationary for a long period to cool down before working on it. • Wear appropriate protective equipment (protective gloves).
	<p>Attention!</p> <p>If the gearbox has no means of identification attached, its technical data cannot be seen and claims for warranty will be null and void.</p> <ul style="list-style-type: none"> • Ensure that the identification plate is attached to the gearbox. • Do not remove the identification plate from the gearbox.
	<p>Attention!</p> <p>Operating materials may be polluting.</p> <ul style="list-style-type: none"> • Ensure that the gearbox is properly disposed of. • Regularly check the gearbox for leaks.

3 Description



Note

The following illustrations should be seen as examples. Depending on gearbox series, size and characteristics, deviations are possible.

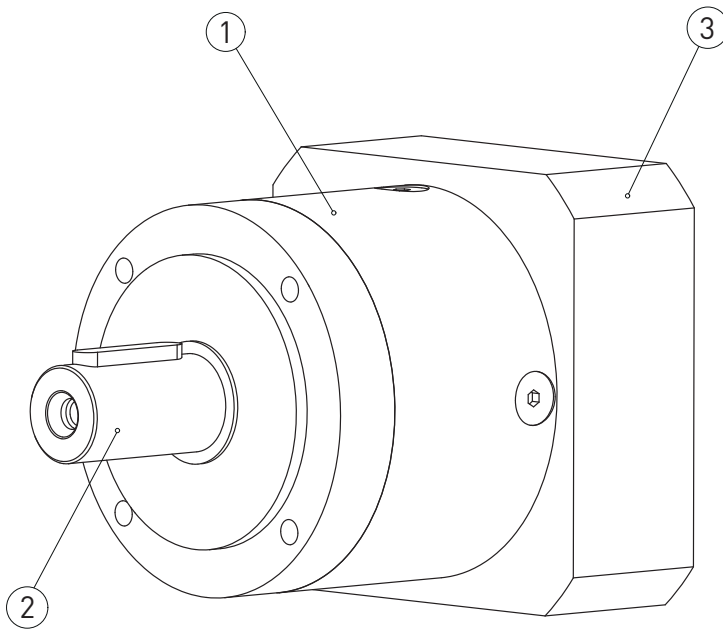

The example shown above describes the following components of a planetary gearbox:

- 1 Gearbox housing
- 2 Output shaft
- 3 Input flange

3.1 Technical data

Gearbox series	PSBN / PSN / PLN / PLHE PSFN / PLFN WPLN / WPSFN / WGN	PLE/PLQE/PLPE/PLFE WPLE/WPLQE/WPLPE WPLFE
Max. permissible operating temperature	+90 °C	+90 °C
Protection class	IP 65	IP 54
Seals	High quality shaft seals	Sealed bearing washers



	Note
	You will find the relevant technical data for the gearbox series, size and ratio in the product catalog, on the dimension sheet, and online at www.neugart.com

3.2 Accessories

3.2.1 Shrink disc

As an accessory for the WGN hypoid planetary gearbox, we can supply an appropriate shrink disc of the relevant size.

Gearbox frame size	WGN070	WGN090	WGN115	WGN142
Shrink disc (art. no.)	58365	58366	58367	58368

	Note
	You will find additional technical data in the product catalog and online at www.neugart.com
	Attention!
	Tightening the clamping screws when the machine shaft is not fitted may misshape the hollow shaft. This may result in damage to property. <ul style="list-style-type: none"> • Only tighten the clamping screws when the machine shaft is fitted.

3.3 Lubrication

All Neugart gearboxes come with lifetime lubrication.

	Note
	<ul style="list-style-type: none"> • The gearboxes can also be ordered with food safe lubricant or low temperature lubricant. • Please note that using the low temperature lubricant at a temperature in excess of 50 °C will result in different performance data. For more details, please consult the dimension sheet for your gearbox. • You will find additional technical data in the product catalog and online at www.neugart.com

3.4 Identification plate

The identification plate is mounted on the input flange and/or gearbox housing. To clearly identify the gearbox, the identification plate must also be clearly legible at all times if installed in a machine and/or system.

The following illustration shows an example of an identification plate for a planetary gearbox from the PSN series:

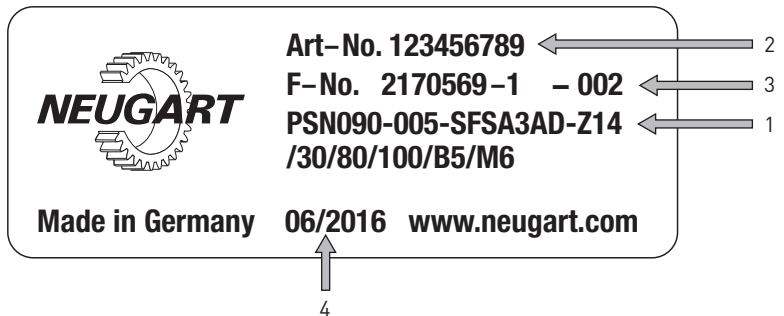



- 1 Product code (For details see Chapter 3.5: Product code)
- 2 Article number
- 3 Serial number
- 4 Month/year of manufacturing

	Note
	<p>Should you have any queries, please include the product code and serial number.</p>

3.5 Product code

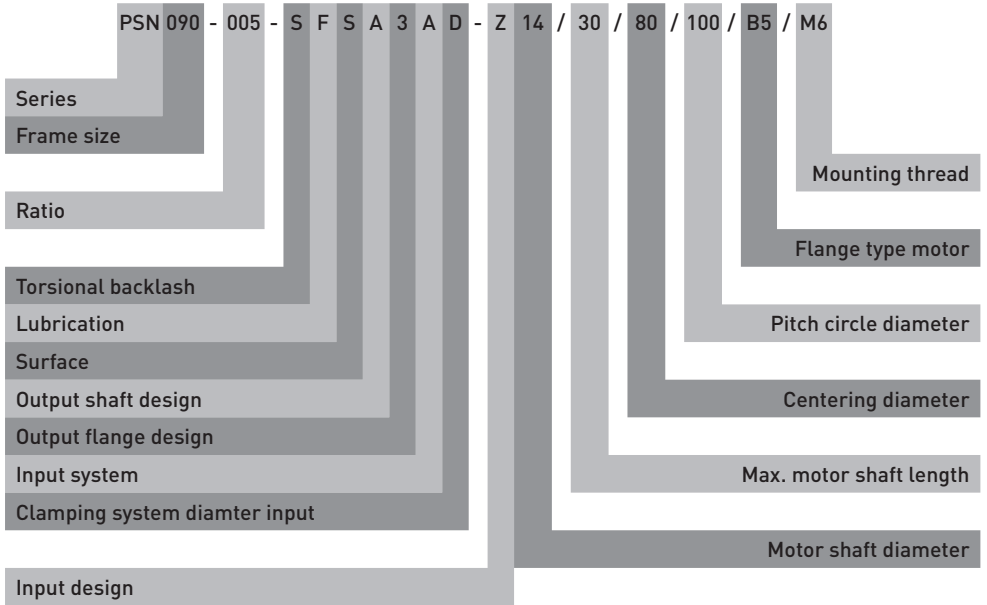
Chapter 3.4 shows an example of an identification plate. The product code shown under point 1 has the following structure:



	Note
	<p>You will also find the complete product code in our product catalog. More information of your gearbox configuration can be found with the Tec Data Finder on our website at www.neugart.com</p>

4 Storage and transport

4.1 Storage



The gearbox should be stored in its original packaging, in a dry place, and not in direct sunlight. At ambient temperatures of between -25 °C and +60 °C, the maximum storage period is 2 years (for permissible transport temperatures, see Chapter 4.2: Transport). Direct sunlight speeds up the aging process of the seals and increases the probability of premature wear.

	Attention!
	<p>The gearbox may be damaged by improper storage. This may result in damage to property.</p> <ul style="list-style-type: none"> Limit the storage time to a minimum. Avoid direct sunlight. Please note the warranty period stated in our general terms and conditions. This may deviate from the permitted storage period.



4.2 Transport

As soon as the gearbox is delivered, check for any transport damage. Report any transport damage to the transport company immediately. This may mean that the gearbox cannot be commissioned.

	Warning!
	<p>When lifting the gearbox to transport it, it may fall and cause serious injuries or even death.</p> <ul style="list-style-type: none"> Never stand under suspended loads. Observe the permissible load-bearing capacity of the lifting gear. Use suitable means of transport of a sufficient size to transport the gearbox.

	Attention!
	<p>The gearbox may be damaged by improper transport. This may result in damage to property.</p> <ul style="list-style-type: none"> Do not drop the gearbox. Only transport gearbox in its packaging. Protect the gearbox and packaging from moisture. The ambient temperatures for gearbox transport should be between -25 °C and +60 °C.
	Note
	<p>Temperature up to 85 °C due to transport are permitted for short periods (approx. 2 weeks). However, temperatures >60 °C may speed up aging of the seals even during these short periods. The seals should therefore be checked before the gearbox is used.</p>

4.3 Condition upon delivery

	Note
	<p>Upon delivery, mounting instructions are provided with the gearbox.</p>
	Note
	<p>You can download other documents including the dimension sheets and operating manual from our website at www.neugart.com</p>

5 Mounting

5.1 Ambient conditions

For smooth operation and to maximize gearbox service life, note the following:



	Attention!
	<p>Failure to observe appropriate ambient conditions may damage the gearbox and shorten its service life.</p> <ul style="list-style-type: none"> Ensure sufficient gearbox convection. Ensure that the gearbox can dispel heat sufficiently via the output flange. The motor and other external sources of heat may heat up the gearbox. Contact the manufacturer for details of motor temperature. Observe the restrictions required by the gearbox's protection class (see Chapter 3.1: Technical data). To ensure the protection class in dusty atmospheres, the cover screw in the input flange must be screwed back in and sealed.

Illustration showing example of input flange with cover screw



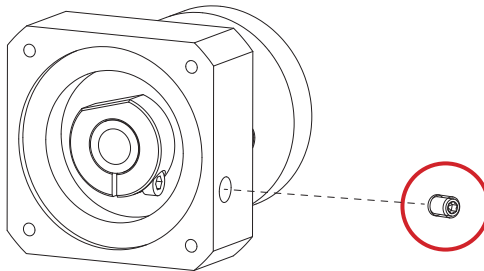

5.2 Preparations for mounting

	<p>Attention!</p> <p>The mounting instructions are needed to mount the motor on the gearbox. Failure to observe the mounting instructions may damage the gearbox.</p> <ul style="list-style-type: none"> • Ensure that the mounting instructions are with the gearbox. If you do not have the mounting instructions, they can be requested from Neugart Service (see Chapter 9: Service).
	<p>Attention!</p> <p>The gearbox's input and output are treated with a corrosion inhibitor. Any corrosion inhibitor remaining may impact negatively on the clamping connections' friction coefficients.</p> <ul style="list-style-type: none"> • Remove all corrosion inhibitor. We recommend a petroleum hydrocarbon based cold cleaner.

5.3 Mounting motor on gearbox

To correctly mount the motor on the gearbox, observe the following steps before starting mounting work:

	<p>Attention!</p> <p>Failure to observe the mounting instructions may damage the gearbox and restrict the gearbox's technical data.</p> <ul style="list-style-type: none"> • Read the mounting instructions carefully. You can also download the mounting instructions from www.neugart.com • Mount the motor on the gearbox as described in the mounting instructions provided with the gearbox packaging. It is essential that the tightening torques stated in the mounting instructions are observed.
	<p>Attention!</p> <p>An excessive motor weight and/or bending moment may damage the gearbox.</p> <ul style="list-style-type: none"> • Ensure that the motor does not exceed the maximum permissible motor weight for the gearbox. You can calculate the permissible motor weight using the permissible bending moment M_b stated in the dimension sheet and the formula provided.

**Note**

Depending on the input flange version, the gearbox should be fitted to a B5 or B14 motor. For the flange type used on your gearbox, please refer to the product code on your identification plate (see Chapter 3.4: Identification plate and Chapter 3.5: Product code). Please note the various mounting variants in the mounting instructions.

5.4 Gearbox mounting

	Note
	The gearboxes can be used in any mounting position.

5.4.1 Output shaft design

Gearboxes are available in the following output shaft designs:

- Output shaft with feather key (DIN 6885-1)
- Smooth output shaft
- Toothed output shaft (DIN 5480)
- Flange output shaft
- Flange output shaft with dowel hole
- Hollow output shaft on one side
- Hollow output shaft on both sides
- Flange output hollow shaft with dowel hole

The possible combinations in output shaft design vary for the individual series.

The details can be found in the current product catalog or online at www.neugart.com

	Attention!
	<p>Bearings, housing or shafts may be damaged by improper mounting and bracing.</p> <ul style="list-style-type: none"> • Never fit pinions, couplings or pulleys on the shaft end by hammering on. • When mounting pulleys, observe the recommended belt tension stated by the manufacturer. • Only mount input and output elements with a fitting tool. To locate, use the centering hole with thread that may be present on the shaft end. • The mounted transmission elements must not cause unauthorized radial or axial forces. Ensure that they are balanced. Consult the dimension sheet for the permissible radial and axial forces. • Only secure couplings, discs, gears, sprockets etc. to the gearbox output shaft with suitable mounting sets.



	Attention!
	<p>Leaks caused by improper seal handling may damage the gearbox.</p> <ul style="list-style-type: none">• Ensure that the seals on the gearbox are not dirtied during installation or damaged by pointed or sharp objects.• Do not use compressed air to clean the gearbox.

5.4.2 Information about gearbox mounting



To mount the gearbox on your application, please note the following:

	Attention!
	<p>An improper application connection may damage the gearbox and restrict the gearbox's technical data.</p> <ul style="list-style-type: none">• Ensure that the receiving seats and locating faces of the gearbox are clean and positioned exactly in relation to the connecting shafts. This will prevent loads harmful to the bearings, shafts, and housing in the overall system caused by offset.• Ensure the exact position of the shafts to be connected.• For gearboxes with an aluminum output flange, use screws of no higher than strength class 10.9, provided that 90% of the screw yield strength is used.• Fix the gearbox with adequate screw tightening torques of the strength class used.

6 Commissioning

	<p>⚠ Warning!</p> <p>Failure to observe the general safety instructions may result in serious damage to property, serious injury, and even death.</p> <ul style="list-style-type: none"> • Before starting work, familiarize yourself with the general safety instructions [see Chapter 2.6: General safety instructions].
	<p>⚠ Warning!</p> <p>Failure to comply with the intended use and technical data may result in serious damage to property, serious injury, and even death.</p> <ul style="list-style-type: none"> • Ensure intended use and observe the technical data (see Chapter 3.1: Technical data).
	<p>Note</p> <p>Operate the gearbox under real application conditions within its technical specification and check how it runs in.</p> <ul style="list-style-type: none"> • Ensure that all components are correctly connected. • Check the running noise. A louder running noise may indicate incorrect motor mounting. • During the first hours of operation, check the gearbox for leaks. • Check the tightening torques of the motor and application screw connection, including the motor shaft's clamp connection. • Operate the gearbox until the drive train is in a thermally steady state and measure the temperature on the gearbox [see Chapter 6.1: Measuring surface temperature]. • Ensure that the permissible gearbox temperature of 90 °C is not exceeded. • Establish the lubricant's service life [see Chapter 7.2: Lubrication].

6.1 Measuring surface temperature



	<p>Attention!</p>
	<p>If the gearbox's maximum permissible operating temperature is exceeded, the gearbox may be damaged by overheating (see Chapter 3.1: Technical data).</p> <ul style="list-style-type: none"> • Ensure that the max. permissible operating temperature of the gearbox is not exceeded during operation (see Chapter 3.1: Technical data). • Switch off the system if the max. permissible operating temperature is exceeded and contact Neugart (see Chapter 9: Service).
	<p>Note</p>
	<p>The maximum operating temperature is based on normal ambient, attachment, and application conditions. Even slight deviations may have a major impact on temperatures. It is therefore imperative that the surface temperature is measured with maximum loading. Ensure that all components are correctly connected.</p> <ul style="list-style-type: none"> • Measure the surface temperature with maximum loading at the center of the housing. The measurement can be taken with conventional temperature measuring devices. • The maximum surface temperature in a thermally steady state is attained when the temperature increase is no more than 2 °C per hour. • You can determine the lubricant's service life from the measured temperature (see Chapter 7.2: Lubrication). • The permissible operating temperature of the gearbox must not be exceeded. At higher temperatures, the system should be switched off immediately and Neugart Service contacted (see Chapter 9: Service).



6.2 Sound emission

	Note
	<p>The sound emissions from the gearbox vary depending on the series and size.</p> <ul style="list-style-type: none">• Generally speaking, gearboxes with helical gearing are quieter than those with straight gearing.• A higher ratio in a planetary stage results in lower sound emissions.• The sound emission stated for a series is determined at a ratio of $i = 5$. The sound pressure level is measured at a distance of 1 m and at an input speed of $n_1 = 3,000$ rpm without load.• You will find the operating noise for your gearbox according to the above specifications in our product catalog or online at www.neugart.com.• Please note that the subjectively perceived sound emission is greatly affected by the damping behavior of the machine/system.

7 Maintenance and disposal

	<p>⚠ Warning!</p>
	<p>Failure to observe the general safety instructions may result in serious damage to property, serious injury, and even death.</p> <ul style="list-style-type: none"> • Before starting work, familiarize yourself with the general safety instructions (see Chapter 2.6: General safety instructions).
	<p>Attention!</p>
	<p>Improper maintenance may damage the gearbox.</p> <ul style="list-style-type: none"> • All maintenance work above and beyond checking seal integrity, noise, and temperature should be performed by Neugart (see Chapter 9: Service). • Defective seals should preferably be replaced by Neugart. Following agreement with Neugart Service, the seals may also be replaced by the end customer if necessary. Original spare parts are available from Neugart Service (see Chapter 9: Service).



7.1 Maintenance intervals

Interval	Check
Commissioning and after 10 hours of operation	<ul style="list-style-type: none"> • Visual inspection of seals on the input and output side for leaks • Noise check • Check of gearbox temperature • Tightening torques of motor and application screw connection, including the motor shaft's clamp

The gearboxes come with lifetime lubrication and require no maintenance.

Please ensure that the gearbox is commissioned correctly (see Chapter 6: Commissioning) and that the gearbox is operated within the technical specifications. Should unforeseeable operating faults occur, please note the additional notes provided in this operating manual (see Chapter 8.1: Operating faults).

7.2 Lubrication

	<p>Attention!</p>
	<p>The lubricant's service life is limited by the gearbox temperature. Using lubricant beyond the end of its service life may result in premature gearbox wear.</p> <ul style="list-style-type: none"> • Check the lubricant's service life as explained in this chapter using the gearbox temperature measured. • Have the lubricant replaced by Neugart if the calculated lubricant service life is shorter than the gearbox service life (see Chapter 9: Service).
	<p>Note</p>
	<p>All Neugart gearboxes come with lifetime lubrication. However, operating the gearbox continuously at high temperatures may result in premature lubricant aging. The diagram provided in this chapter should serve to predict the anticipated lubricant service life based on the gearbox temperature measured (in a thermally steady state). To do this, proceed as follows:</p> <ul style="list-style-type: none"> • Measure the temperature as described in Chapter 6.1: Measuring surface temperature. • Add 10 °C to the measured temperature to obtain the gearbox core temperature. • Use this temperature to calculate the service life of the lubricant from the diagram.



Lubricant service life

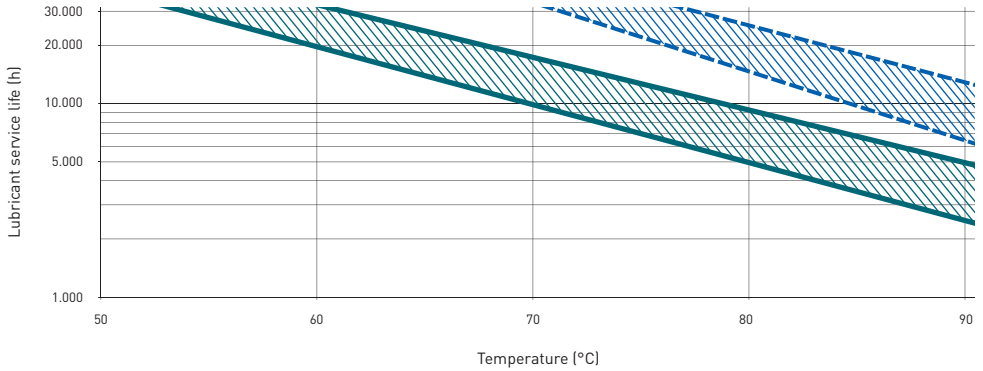

- t [h] Service life of lubricant
- T [°C] Operating temperature with continuous operation
- PLE/PLQE/PLPE/PLHE/PLFE/WPLE/WPLQE/WPLPE/WPLFE
- - PSBN/PSN/PLN/PSFN/PLFN/WPLN/WPSFN/WGN

7.3 Seals

	Note
	The service life of the seals depends on the application and ambient conditions.

7.4 Disposal

	Attention!
	<p>Escaping operating materials and improper disposal may harm the environment.</p> <ul style="list-style-type: none">• Dispose of greases and oils separately.• The gearbox and packaging materials should be disposed of in line with environmental legislation.• Observe the applicable national regulations on proper disposal.• If you have any questions relating to disposal contact Neugart Service (see Chapter 9: Service).

8 Operating faults

8.1 Remediating operating faults

Danger	Possible cause	Solution
Unusual or loud running noise	Bearing damage	Contact Neugart Service
	Gearing damage	
Increased operating temperatures	Restricted air supply	Ensure sufficient cooling
	Motor is heating the gearbox	Ensure sufficient cooling
	The gearbox is not suitable for the load cycle, ambient conditions	Check the technical data Contact Neugart Service
Lubricant escaping	Seal defective	Contact Neugart Service

	<p>Note</p>
	<p>If you would like assistance in remediating the operating fault, please contact Neugart Service (see Chapter 9: Service) and have the following details on hand:</p> <ul style="list-style-type: none"> • Complete identification plate • Type and extent of fault • Attendant circumstances and time of fault • Presumed cause



9 Service

We are happy to assist with further questions and problems associated with the drive technology.

Address for returns

Neugart GmbH
Werk 2
Customer Service
Keltenstraße 18
77971 Kippenheim
Germany

Phone +49 7825 847-3535
Fax +49 7825 847-433535
Email service@neugart.com
Web www.neugart.com



Neugart GmbH

Keltenstraße 16 ■ 77971 Kippenheim ■ Germany

Phone +49 7825 847-0 ■ Fax +49 7825 847-2999

www.neugart.com ■ sales@neugart.com